

LED Indoor Luminaires

Ceiling Mount – with Motion Sensor & Emrg

120-277 VAC / 60Hz

Model #: AVNL4848LAJD2xx-MSBB
AVNL9685LAJD2xx-MSBB

Safety Precautions

- Read all safety precautions and installation instructions carefully before installing or servicing this fixture. Failure to comply with these instructions could result in potentially fatal electric shock and/or property damage.
- It is recommended that a qualified electrician perform all the wiring. This fixture must be wired in accordance with all national and local electrical codes.
- Do not handle any energized fixture or attempt to energize any fixture with wet hands or while standing on a wet or damp surface or in water.
- This fixture is designed for use in a 120-277VAC, 60Hz fused circuit. This fixture is not compatible with a dimming circuit.
- To reduce the risk of electrical shock, and to assure proper operation, this fixture must be adequately grounded. To accomplish proper grounding, there must be a separate ground wire (green) contact between this fixture and the ground connection of your main power supply panel.
- This fixture is intended to be used for general outdoor lighting in dry or damp locations.
- Disclaimer
Changes or modifications not expressly approved by the party responsible for compliance could void the user's authority to operate the equipment. NOTE: This equipment has been tested and found to comply with the limits for a Class B digital device, pursuant to Part 15 of the FCC Rules and Canadian ICES-005 (B) / NMB-005 (B). These limits are designed to provide reasonable protection against harmful interference in a residential installation. This equipment generates, uses, and can radiate radio frequency energy and, if not installed and used in accordance with the instructions, may cause harmful interference to radio communications. However, there is no guarantee that interference will not occur in a particular installation. If this equipment does cause harmful interference to radio or television reception, which can be determined by turning the equipment off and on, the user is encouraged to try to correct the interference by one or more of the following measures:
 - Reorient or relocate the receiver antenna.
 - Increase the separation between the equipment and receiver.
 - Connect the equipment into an outlet on a circuit different from that to which the receiver is connected.
 - Consult with the dealer or an experienced radio/TV technician for help.

Any modifications to this fixture may void the warranty and interfere with the safe operation of the luminaire.

Operation is subject to the following two conditions: (1) this device may not cause interference, and (2) this device must accept any interference, including interference that may cause undesired operation of the device.

Assembly Instructions

Step 1 – Preparing for installation

- Disconnect electrical power** at the fuse or circuit breaker box before installing or servicing any part of this fixture.
- Carefully remove the fixture and parts bag from the carton.
- Remove components from the parts bag.
- Release the diffuser assembly (2) from the fixture (1) by depressing on the housing side near the tabs and pull at the same time to disengage from the slots. Diffuser assembly is tethered to the fixture on both ends.
- Disconnect the LED power cord by twisting counterclockwise and pull to separate connection then unclip both tether wires. Place diffuser assembly off to the side.
- Identify the location of mounting the fixture relative to power source. 0.875" K/O are supplied for power connection at end or through the top. Fitting is not supplied for cord connection. If the top is used for connection, remove knockout and temporarily align holes to junction box (not provided). Using pencil to mark two locations using hole on the fixture as template for additional anchoring to the ceiling.
- Take the fixture down and punch a small hole into the ceiling at each marked location using a nail or awl to see if there is a wood joist. If there is a joist, use a wood screw (5) to mount the fixture housing. Where there is no joist to screw into, use drywall anchors (4) & (5) or toggle bolts (not provided) of suitable length to mount housing securely to the ceiling.

Step 2 – Mounting fixture

- Mount the fixture to the ceiling using two screws (3) and two wood screws (5) to secure it while passing the supply wires into the opening of the housing.

Wiring – All wiring must take place inside junction box (not included)

Caution: Make sure power is off at fuse or circuit breaker box. Check power wires for damage or scrapes. Use wire suitable for at least 90°C (194°F). **Note:** Most dwellings built before 1985 have supply wire rated to 60°C. Consult a qualified electrician to ensure correct branch circuit conductor before installing.

Step 3 – Wiring fixture

- Make all wire connections to appropriate wire. Secure with wire nuts (provided).
- Connect the green wire from the fixture to the supply power source ground wire.
- For non-dimming.** Connect the black wire from the fixture to the black (L) wire from the supply power source. Connect the white wire from the fixture to the white (N) wire from the supply power source. Pink and purple wires are not to be used and must be individually capped to prevent shorting.
- For (0-10V) dimming.** Connect the pink wire from the fixture to the dimmer source pink (or gray) wire. Connect the purple wire from the fixture to the dimmer source purple wire. Connect the white wire from the fixture to the neutral (N) wire from the dimming source per dimmer wiring instructions. Connect the black wire from the fixture to the control line (L) wire from the dimmer supply power source per dimmer wiring instructions.
- Do not mix wires. Pull on each wire lead to make sure connections are secure. Make certain no bare wires are exposed outside of wire connectors.

Step 4 – Color changing temperature adjustment, CCT (if desired)

- Adjust CCT switch according to the desired color temperature as shown below. Note: Fixture is preset to 3000K from factory.

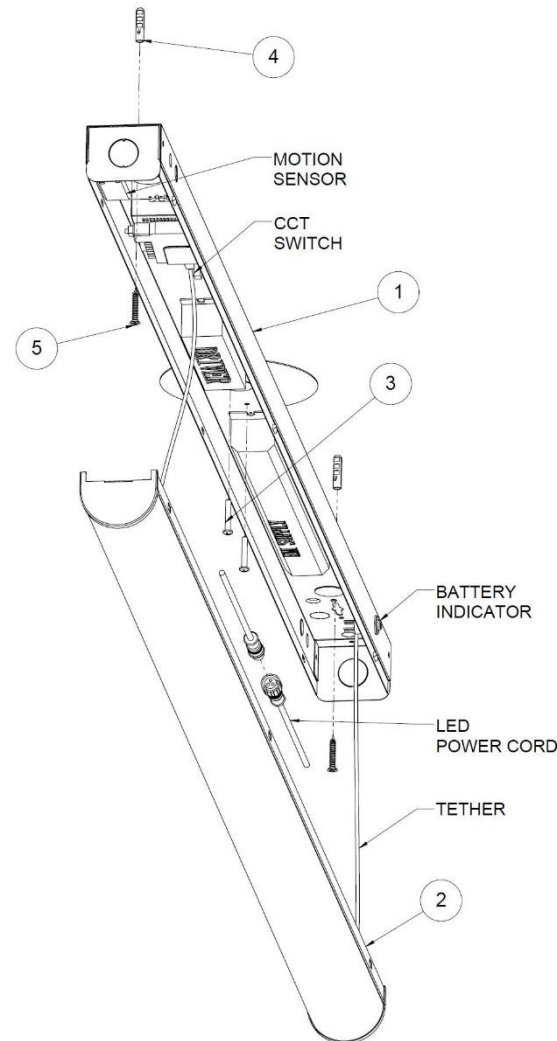
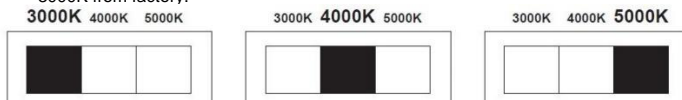

View shown for reference only. Individual models may vary.

LED Indoor Luminaires Ceiling Mount – with Motion Sensor & Emrg 120-277 VAC / 60Hz

Model #: AVNL4848LAJD2xx-MSBB
AVNL9685LAJD2xx-MSBB

Step 5 – Diffuser Assembly installation

- Reconnect both tether wires onto the diffuser assembly (2).
- Reconnect LED power cord connector together and twist clockwise until snug.
- Align the slot to the tab on one side of the fixture then squeeze the other side just enough until all tabs are fully engaged. Note: all tabs and slots must be interlocked together.

Step 6 – Restore power at the fuse or circuit breaker box

Mounting spacing for reference:

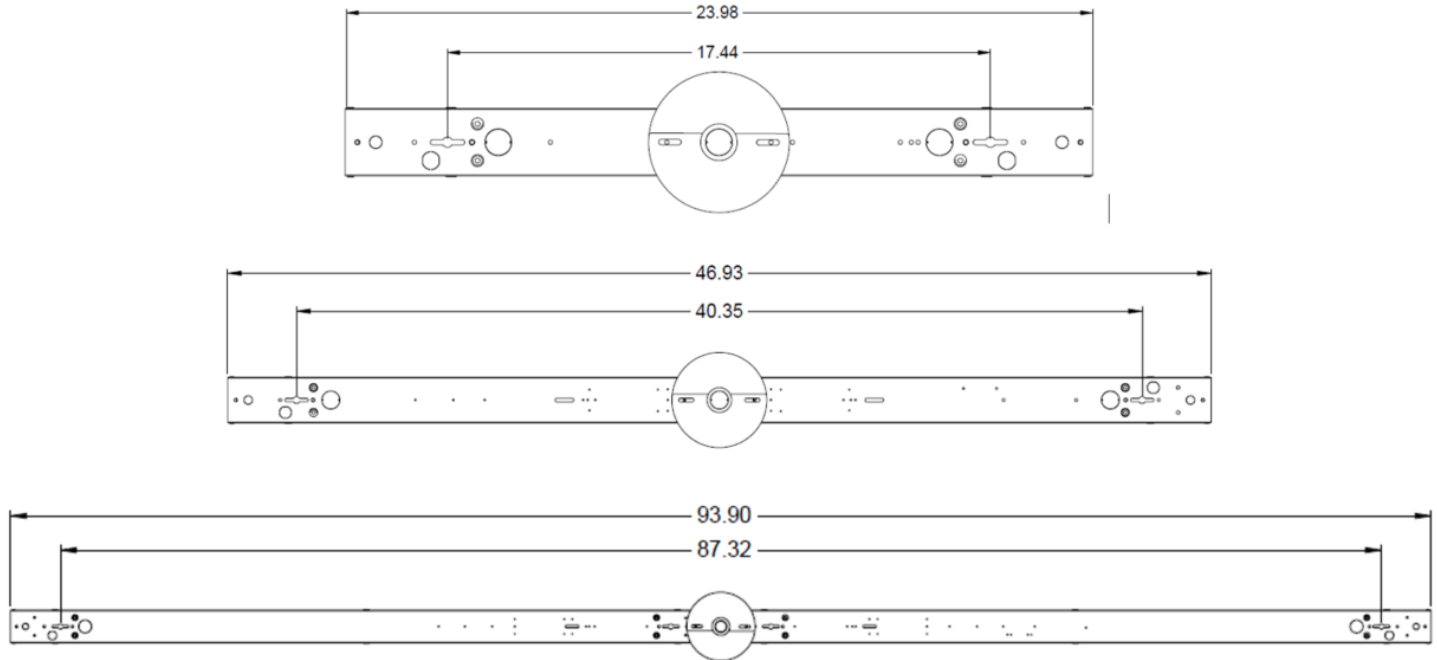

Motion Sensor Operation:

1. On-off function (Stand-by Period “0s”)

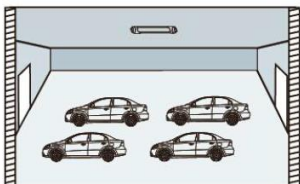

- With sufficient ambient light, the light will not be switched on even if with motion signal.

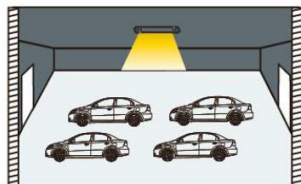

- With insufficient ambient light, the sensor switches on the light when motion is detected.



- After elapse of hold time, the sensor switches off the light when no motion is detected.

2. 2-step dimming function (Stand-by Period “+∞”)

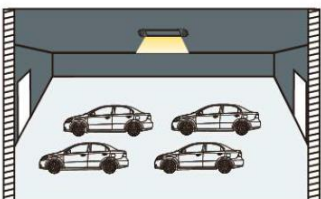

- If there is no motion detected, the light will be remained at a low light level all the time.

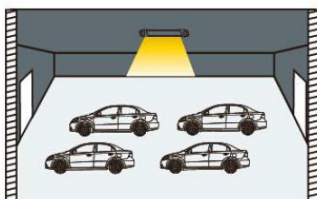

- When motion is detected, the sensor will switch on the light to 100% brightness

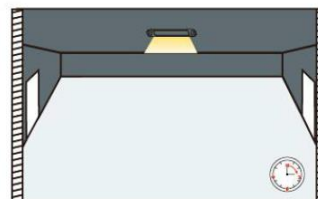

- After elapse of hold time, the sensor dims the light at the present low light level if no motion is detected.

LED Indoor Luminaires Ceiling Mount – with Motion Sensor & Emrg 120-277 VAC / 60Hz

Model #: AVNL4848LAJD2xx-MSBB
AVNL9685LAJD2xx-MSBB

3. 3-step dimming function (Stand-by Period “5s/5min/10min/30min/1h”)

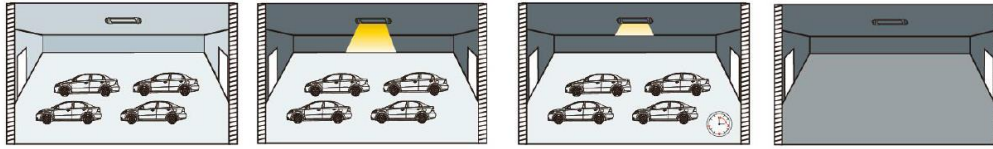

- 1 With sufficient ambient light, the light will not be switched on even if with motion signal.
- 2 With insufficient ambient light, the sensor switches on the light when motion is detected.
- 3 After elapse of hold time, the sensor dims the light at a low light level if no new motion is detected.
- 4 After elapse of standby period, the sensor switches off the light if no motion is detected in the detection zone.

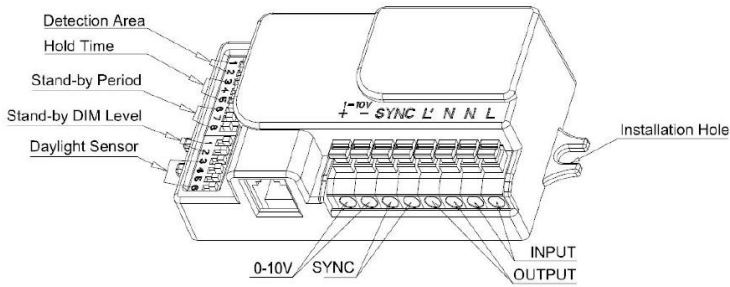

Height: 3m

Sensitivity: 100%/75%/50%/25%

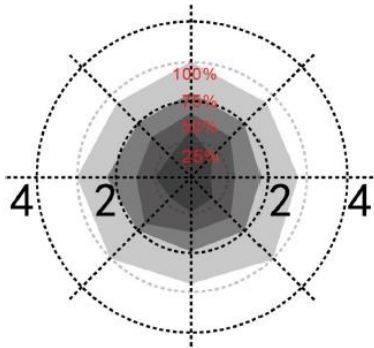

Normal moving (Speed: 1m/s)

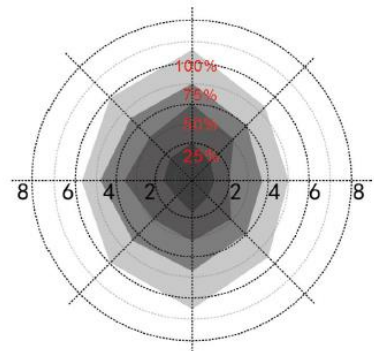

Slow moving (Speed 0.3m/s)

Height: 6m

Sensitivity: 100%/75%/50%

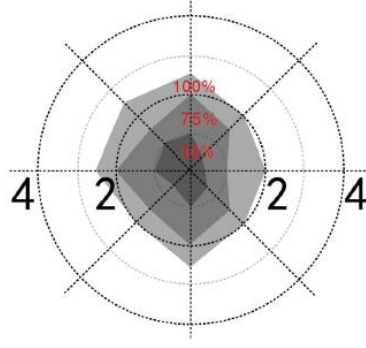

Normal moving (Speed: 1m/s)

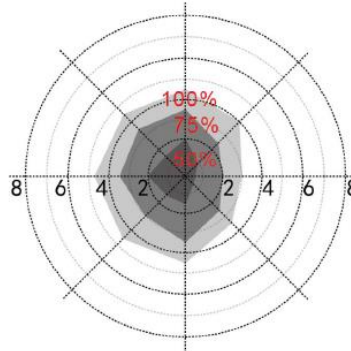

Slow moving (Speed 0.3m/s)

LED Indoor Luminaires Ceiling Mount – with Motion Sensor & Emrg 120-277 VAC / 60Hz

Model #: AVNL4848LAJD2xx-MSBB
AVNL9685LAJD2xx-MSBB

Dip switch settings

Detection Area

	1	2	
I	ON	ON	100%
II	ON		75%
III	-	ON	50%
IV	-	-	25%

Hold Time

	3	4	5	
I	ON	ON	ON	5sec
II	-	ON	ON	30sec
III	ON	-	ON	90sec
IV	-	-	ON	3min
V	ON	ON	-	20min
VI	-	-	-	+ ∞

Standby Period

	6	7	8	
I	ON	ON	ON	0sec
II	-	ON	ON	5sec
III	ON	-	ON	5min
IV	-	-	ON	10min
V	ON	ON	-	30min
VI	-	ON	-	1hr
VII	-	-	-	+ ∞

Standby dimming level

	1	2	Brightness
I	ON	ON	50%
II	-	ON	30%
III	ON	-	20%
IV	-	-	10%

Daylight Sensor

	3	4	5	6	
I	ON	ON	ON	ON	5Lux
II	-	ON	ON	ON	15Lux
III	ON	-	ON	ON	30Lux
IV	-	-	ON	ON	50Lux
V	ON	ON	-	ON	100Lux
VI	ON	ON	ON	-	150Lux
VII	-	-	-	-	Disable

Initialization

1. Switch function/three-stage dimming function: the light will be turned on 100% brightness by the initial energizing sensor, and will be turned off after 10 seconds. During initialization, no external motion sensing signal will be detected.
2. Two-phase dimming function: the light will turn on 100% brightness in the initial energizing sensor, and turn to low brightness 10 seconds later (the brightness set by standby dim level). During initialization, no external motion sensing signal will be detected.

Factory setting

Detection Area: 100%, Hold Time: 5sec, Daylight Sensor: Disable, Stand-by Period: 0sec, Dimming brightness preset function: 50%

Application notice

1. The sensor should be installed by a professional electrician. Please turn off the power before installing, wiring, changing the setting of the DIP switch.
2. The sensor which installed in the plastic and glass lampshade will reduce the sensitivity. For every 3mm increase in thickness, the sensitivity will be reduced by 20%.
3. The light sensitivity threshold is in a sunny environment, no shadow and ambient light diffuse reflection. Ambient lux level could be different in different environment, weather, climate, time-of day and season.
4. The parameters of the sensor may need to be reconfigured in different installation environments.
5. This sensor is for indoor use only. It will affect the waterproof effect for outdoor use. Wind, rain, and moving objects around will cause false triggering.
6. The distance between any inductive sensors should be greater than 3m.
7. Do not place the sensor close to high-density objects such as metal, glass, concrete walls, etc, false triggering could happen. When the sensor is installed in a metal lamp, metal reflective surface, or a narrow enclosed environment, the microwave will be reflected repeatedly and cause false triggering. Please reduce the sensitivity or contact the manufacturer for technical support.
8. Please ensure that there are no moving signals around the sensor, such as fan, DC motor, sewer pipe, air outlet, etc., the sensor may generate false trigger.
9. The data on detection pattern is typical value tested without any lighting fixture in factory, the detection range could be affected by moving speed, installation height, motion object and different environment.
10. Due to continuous improvement, the contents of this instruction could be changed without prior notice.

LED Indoor Luminaires Ceiling Mount – with Motion Sensor & Emrg 120-277 VAC / 60Hz

Model #: AVNL4848LAJD2xx-MSBB
AVNL9685LAJD2xx-MSBB

Emergency Back Up:

Operation

AC Operation:

AC power is present, The LED load from the LED driver is normal power supply, AC LED driver output current can not exceed 150W or 4A, the emergency driver is charging in a standby mode. The green LED light flashes indicates that it is charging. The green LED light on indicates that it is full charged. After the AC power supply working 48h, The emergency LED drive will automatically from AC power working switch into emergency working mode for 30S every month and then automatically backs to the working mode of the AC power supply, the AC power supply works per year for automatically from the AC power mode backs to the working emergency mode until the emergency discharge is completed.

Emergency operation:

When the AC power goes out, The emergency driver detects the AC power outage and automatically switch to the emergency mode.

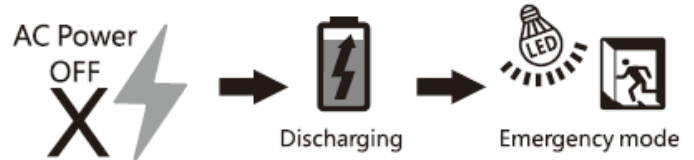
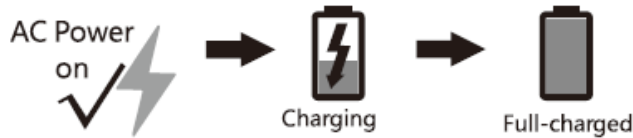

Indicator light introduction

- ① Green/flashing: Charging
- ② Green/on: Full-charged
- ③ Red/on: Discharging(emergency mode)
- ④ Red/flashing: Discharging(emergency mode) finished soon
- ⑤ Yellow/on: Error

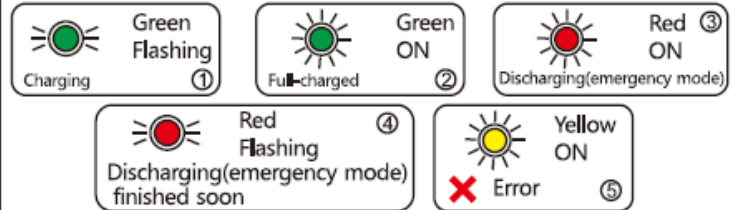

Test switch introduction

Press the test switch to confirm whether the emergency function is normal



Limited Factory Warranty

AFX warrants this fixture is free from defects in materials and workmanship when installed and used under normal operating conditions for a period of 5 years from date of purchase. This warranty covers all component parts and extends only to replacement of defective fixture or components; it does not cover failure due to improper installation, misuse, mishandling or damage incurred in transit.